



- the original since 1922

# THE WORLD'S STRONGEST CAULKING GUNS



**POWER ■ PRECISION ■ RELIABILITY**

Caulking guns for the most challenging tasks



## Product Catalogue

Krøger A/S - Geminivej 4-6 - DK-2670 Greve - Denmark  
Tel.: +45 4360 0111 - Fax: +45 4369 0137 - Email: [mail@mk-guns.dk](mailto:mail@mk-guns.dk)



- the original since 1922

# REGULATION

## **A comprehensive product range and a new catalog**

Welcome to our new product catalog where you will find an extensive range of caulking guns and accessories. Our products are developed to meet any imaginable challenge connected to sealing, caulking or adhesives in the industry or construction business! Here, in the new catalog, you will find them all.

Although the world is moving towards ever more digitalization and, for most of us the main source of information is the Internet, we find that many of our customers still would like to have a physical copy. To meet these wishes, we have made it possible to download and print our catalog. You can choose whether you want to print out the complete catalog or just the parts of it, relevant to your needs.

We have chosen this option because it fits our values to demonstrate responsibility. Responsibility towards the environment and towards the daily costs.

Krøger A/S continuously develops new products. Constantly updating and reprinting catalogs would involve a great waste of resources and paper. With today's digital opportunities, we can present you with an updated catalog, featuring the current range - without having to burden the environment unnecessarily.

The catalog is divided into product groups. This makes it easy for you to make your choice and download exactly what you need. And it is available around the clock, - no waiting for the mail.

Enjoy your reading!

**Peter Gad**  
CEO Krøger A/S



- the original since 1922

# CONTENT

## PRODUCTS:

### ▶ Accessories

Nozzles	s. 04
Pressure Plates	s. 12
Suction Disc	s. 15
Mixing Equipment	s. 19
Pistons	s. 21
Sealing Sticks	s. 24
Quick Coupling Set	s. 25



- the original since 1922 -

## Metal Nozzles

### Metal Nozzles

All of the MK-nozzles are adaptable with any of our one-component MK-Caulking Guns. For some of our guns you will, however, need our nozzle adaptor (ref.1630) to mount the nozzles.

	Nozzle no.	Inside measure in mm (d)	Length mm (h)	
	031	ø4	65	
	041	ø4	150	
	032	ø6	65	
	042	ø6	150	
	033	ø8	65	
	043	ø8	150	
	034	ø10	65	
	044	ø10	150	
	035	ø12	65	
	045	ø12	150	
	036	ø15	65	
	046	ø15	150	
	Nozzle no.	Inside measure in mm (b x l)	Length mm (h)	
	037	2 x 6	65	
	047	2 x 6	150	
	049	2 x 20	150	
	039	2 x 20	65	
	048	3 x 10	150	
	038	3 x 10	65	

Krøger A/S - Geminivej 4-6 - DK-2670 Greve - Denmark - Phone: +45 43600111 - Fax: +45 43690137  
[www.mk-guns.dk](http://www.mk-guns.dk) - [mail@mk-guns.dk](mailto:mail@mk-guns.dk)





- the original since 1922 -

## Metal Nozzles

The World's Strongest Caulking Gun

	Nozzle no.	Inside measure in mm (b x l)	Length mm (h)	
	040	3 x 10	65	
	Nozzle no.	Inside measure in mm (d)	Length mm (h)	
	050	ø4	150	
	051	ø6	150	
	052	ø8	150	
	053	ø10	150	
	054	ø12	150	
	055	ø15	150	
	Nozzle no.	Inside measure in mm (b x l)	Length mm (h)	
	056	2 x 6	150	
	058	2 x 20	150	
	057	3 x 10	150	

Krøger A/S - Geminivej 4-6 - DK-2670 Greve - Denmark - Phone: +45 43600111 - Fax: +45 43690137  
[www.mk-guns.dk](http://www.mk-guns.dk) - [mail@mk-guns.dk](mailto:mail@mk-guns.dk)



- the original since 1922 -

## Metal Nozzles

The World's Strongest Caulking Gun

	Nozzle no.	Inside measure in mm (b x l)	Length mm (h)	
	065	3 x 30	75	
	066	3 x 40	75	
	067	3 x 50	90	
	068	3 x 60	95	
	069	4 x 70	100	
	070	4 x 80	100	
	Nozzle no.	Inside diameter	Outside diameter	Length (h)
	059	ø10,5mm	ø13	220

Krøger A/S - Geminivej 4-6 - DK-2670 Greve - Denmark - Phone: +45 43600111 - Fax: +45 43690137  
[www.mk-guns.dk](http://www.mk-guns.dk) - [mail@mk-guns.dk](mailto:mail@mk-guns.dk)



- the original since 1922 -

## Metal Nozzles

The World's Strongest Caulking Gun

	Nozzle no.	Inside diameter	Outside diameter	Length (h)
	060	ø10,5mm	ø13	220
	Nozzle no.	Inside diameter	Outside diameter	Length (h)
	061	7 x 13mm	10 x 16mm	220

Krøger A/S - Geminivej 4-6 - DK-2670 Greve - Denmark - Phone: +45 43600111 - Fax: +45 43690137  
[www.mk-guns.dk](http://www.mk-guns.dk) - [mail@mk-guns.dk](mailto:mail@mk-guns.dk)



- the original since 1922 -

## Metal Nozzles

The World's Strongest Caulking Gun

	Nozzle no.	Inside diameter	Outside diameter	Length (h)
	062	7 x 13mm	10 x 16mm	220
	Nozzle no.	Outside diameter	Length mm (h)	
	064	ø22	220	

Krøger A/S - Geminivej 4-6 - DK-2670 Greve - Denmark - Phone: +45 43600111 - Fax: +45 43690137  
[www.mk-guns.dk](http://www.mk-guns.dk) - [mail@mk-guns.dk](mailto:mail@mk-guns.dk)



- the original since 1922 -

## Metal Nozzles

The World's Strongest Caulking Gun

	Nozzle no.	Nozzle opening	Length mm (h)	
	064a	23,5 x 12,5mm	220	

Krøger A/S - Geminivej 4-6 - DK-2670 Greve - Denmark - Phone: +45 43600111 - Fax: +45 43690137  
[www.mk-guns.dk](http://www.mk-guns.dk) - [mail@mk-guns.dk](mailto:mail@mk-guns.dk)

Krøger A/S cannot be held responsible for any information as to the use of its products mentioned in this datasheet  
 All information is subject to change without prior notice.





- the original since 1922 -

## Plastic Nozzles

### Plastic Nozzles

All of the MK-nozzles are adaptable with any of our one-component MK-Caulking Guns. For some of our guns you will, however, need our nozzle adaptor (ref.1630) to mount the nozzles.

	Nozzle no.	Inside measure in mm (d)	Length mm (h)	
	063	ø2	120	
	Nozzle no.	Inside measure in mm (b x l)	Length mm (h)	
	163	ø2.5	143	

Krøger A/S - Geminivej 4-6 - DK-2670 Greve - Denmark - Phone: +45 43600111 - Fax: +45 43690137  
[www.mk-guns.dk](http://www.mk-guns.dk) - [mail@mk-guns.dk](mailto:mail@mk-guns.dk)





- the original since 1922 -

# Nozzels For Thermo Windows

## For Thermo Windows

All of the MK-nozzles are adaptable with any of our one-component MK-Caulking Guns. For some of our guns you will, however, need our nozzle adaptor (ref.1630) to mount the nozzles.

	Nozzle no.	Standard dimensions of nozzle		
	078	6mm 9mm 12mm 15mm 20mm		
	Nozzle no.	Standard dimensions of nozzle		
	079	6mm 9mm 12mm 15mm 20mm		

Krøger A/S - Geminivej 4-6 - DK-2670 Greve - Denmark - Phone: +45 43600111 - Fax: +45 43690137  
www.mk-guns.dk - mail@mk-guns.dk





- the original since 1922 -

## Pressure Plates ø 51 mm

### Pressure Plates ø 51 mm

Pressure plate for cylinder ø 51mm

Material: Steel

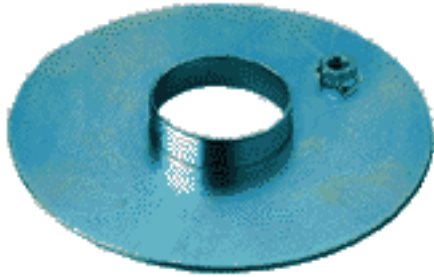
	Article no.	Standard dimensions of disc	For gun no.
	087	153mm 159mm 184mm 268mm 280mm	H2 H3 H202 H203 T20

The World's Strongest Caulking Gun



Krøger A/S - Geminivej 4-6 - DK-2670 Greve - Denmark - Phone: +45 43600111 - Fax: +45 43690137  
www.mk-guns.dk - mail@mk-guns.dk



- the original since 1922 -

# Choice and Use of Pressure Plates

## Choice and Use of Pressure Plates

The diameter of the pressure plate has to be the same size as the bottom diameter of the container that it is refilled from.

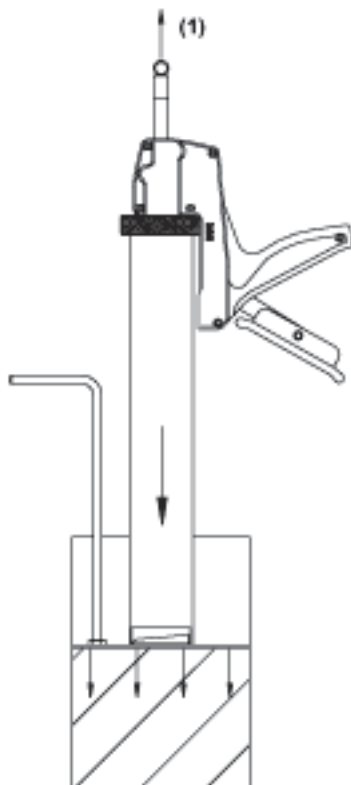
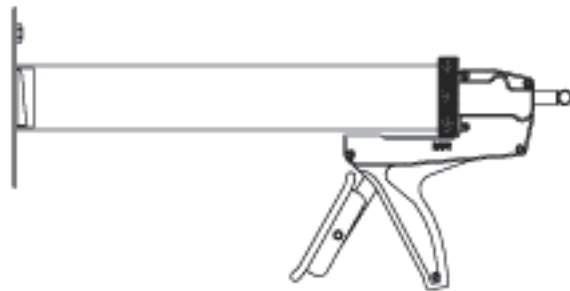

The pressure plate is pressed up into the cylinder before refilling takes place.

During refilling of the gun, which is done by drawing back the piston rod (1), it is important that the pressure plate is being pressed down into the container while sucking the contents up into the gun.





- the original since 1922 -

# Handle for Pressure Plates

## Handle for Pressure Plates

	Article no.		
	091		

The World's Strongest Caulking Gun



Krøger A/S - Geminivej 4-6 - DK-2670 Greve - Denmark - Phone: +45 43600111 - Fax: +45 43690137  
[www.mk-guns.dk](http://www.mk-guns.dk) - [mail@mk-guns.dk](mailto:mail@mk-guns.dk)



- the original since 1922 -

## Suction Disc ø 51 mm

### Suction Disc ø 51 mm

Suction disc for steel cylinder ø 51mm.  
Material: steel.

	Article no.	Standard dimensions of disc	For gun no.
	088	159mm 184mm 268mm 280mm	H2 H3 H202 H203 T20

The World's Strongest Caulking Gun



Krøger A/S - Geminivej 4-6 - DK-2670 Greve - Denmark - Phone: +45 43600111 - Fax: +45 43690137  
www.mk-guns.dk - mail@mk-guns.dk



- the original since 1922 -

## Suction Disc ø 66 mm

### Suction Disc ø 66 mm

	Article no.	Standard dimensions of disc	For gun no.
	089	153mm 159mm 184mm 268mm 280mm	H10 H10/1,2 T25
	Article no.	Standard dimensions of disc	For gun no.
	089g	153mm 159mm 184mm 268mm 280mm	T25A/1,5 T25AX

Krøger A/S - Geminivej 4-6 - DK-2670 Greve - Denmark - Phone: +45 43600111 - Fax: +45 43690137  
www.mk-guns.dk - mail@mk-guns.dk





- the original since 1922 -

## Choice and Use of Suction Disc

### Choice and Use of Suction Disc

The diameter of the Suction disc has to be the same size as the bottom diameter of the container that it is refilled from.

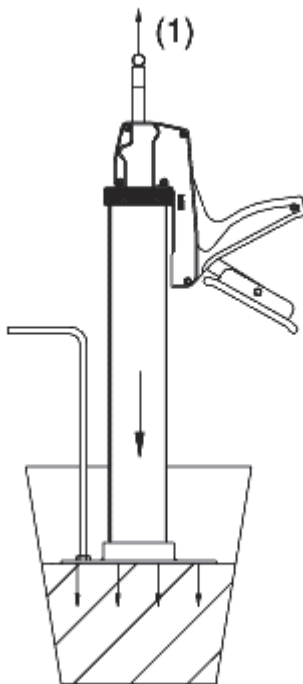
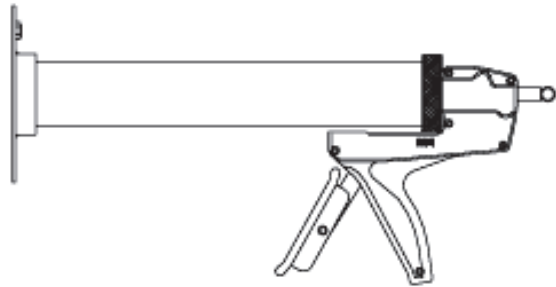
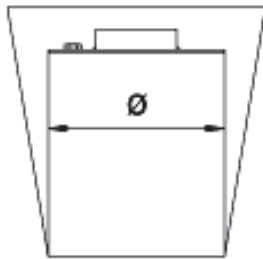

The suction disc must be fastened directly onto the cylinder before refilling takes place

During refilling of the gun, which is done by drawing back the piston rod (1), it is important that the suction disc is being pressed down into the container while sucking the contents up into the gun.





- the original since 1922 -

## Handle for Suction Disc

### Handle for Suction Disc

	Article no.		
	091		

Krøger A/S - Geminivej 4-6 - DK-2670 Greve - Denmark - Phone: +45 43600111 - Fax: +45 43690137  
[www.mk-guns.dk](http://www.mk-guns.dk) - [mail@mk-guns.dk](mailto:mail@mk-guns.dk)







- the original since 1922 -

## Mixing equipment

### Mixing equipment

		
Article no.	Dimensions	Descriptions
101	Length : 460mm Diameter : ø55mm	For cartridges ø 90mm and container
		
Article no.	Dimensions	Descriptions
133	ø45mm	For cartridges ø 50mm

Krøger A/S - Geminivej 4-6 - DK-2670 Greve - Denmark - Phone: +45 43600111 - Fax: +45 43690137  
www.mk-guns.dk - mail@mk-guns.dk





- the original since 1922 -

# Mixing Stand/Holder

## Mixing Stand/Holder

	Article no.	Descriptions	
	132/ø51	For standard cartridges ø51mm	
	132/ø91	For standard cartridges ø91mm	

Krøger A/S - Geminivej 4-6 - DK-2670 Greve - Denmark - Phone: +45 43600111 - Fax: +45 43690137  
[www.mk-guns.dk](http://www.mk-guns.dk) - [mail@mk-guns.dk](mailto:mail@mk-guns.dk)







- the original since 1922 -

## Pistons for cartridges

### Pistons for cartridges

Our wide experience within the construction of pistons has helped us to manufacture the optimum piston solution for use in any situation. The piston must push correctly on the current surface, and ensure an optimum emptying.

	<b>Piston no.</b>	<b>For gun no.</b>	
	1407	H1 H12 H13 H14 H14B H14C H45 H45B H45C H212 H213 H245 TS400X TS404LX TS493X	
	<b>Piston no.</b>	<b>For gun no.</b>	
	4007	H40 H40B H40C	

Krøger A/S - Geminivej 4-6 - DK-2670 Greve - Denmark - Phone: +45 43600111 - Fax: +45 43690137  
www.mk-guns.dk - mail@mk-guns.dk







- the original since 1922 -

# Pistons for Sachets and Bulk

## Pistons for Sachets and Bulk

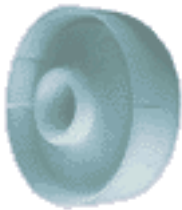
Our wide experience within the construction of pistons has helped us to manufacture the optimum piston solution for use in any situation. The piston must push correctly on the current surface, and ensure an optimum emptying.

	<b>Piston no.</b> 41107	<b>For gun no.</b> H2A H3A H12 H12W H13 H13W H212 H213 TS411X	
	<b>Piston no.</b> 2007	<b>For gun no.</b> T20 T17X T18X H2 H3 H202 H203	
	<b>Piston no.</b>	<b>For gun no.</b>	
	2107	T21X T22X	

Krøger A/S - Geminivej 4-6 - DK-2670 Greve - Denmark - Phone: +45 43600111 - Fax: +45 43690137  
www.mk-guns.dk - mail@mk-guns.dk





- the original since 1922 -

# Pistons for Sachets and Bulk

The World's Strongest Caulking Gun

	<b>Piston no.</b>	<b>For gun no.</b>	
	30008	H2 H3 H202 H203 T17X T18X T20	
	<b>Piston no.</b>	<b>For gun no.</b>	
	30043	H10 H10/1,2 H10/1,5 T25 T25AX TS300GX	
	<b>Piston no.</b>	<b>For gun no.</b>	
	6907	T69XU	

Krøger A/S - Geminivej 4-6 - DK-2670 Greve - Denmark - Phone: +45 43600111 - Fax: +45 43690137  
www.mk-guns.dk - mail@mk-guns.dk



- the original since 1922 -

## Sealing Stick/Wood

### Sealing Stick/Wood

	Article no.	The Sealing Stick is available in these standard dimensions
	094	06mm 08mm 10mm 15mm 20mm 25mm 30mm 40mm

The World's Strongest Caulking Gun



Krøger A/S - Geminivej 4-6 - DK-2670 Greve - Denmark - Phone: +45 43600111 - Fax: +45 43690137  
[www.mk-guns.dk](http://www.mk-guns.dk) - [mail@mk-guns.dk](mailto:mail@mk-guns.dk)

Krøger A/S cannot be held responsible for any information as to the use of its products mentioned in this datasheet  
 All information is subject to change without prior notice.





- the original since 1922 -

# Quick Coupling Set no. 1

## Quick Coupling Set no. 1

All of the MK-pneumatic Caulking Guns are supplied with a 1/4" European thread fitting, but upon request we supply also with 1/4" US thread. Please contact us if you have any additional requests.

	Article no.	Description
	1617 48917	1/4" ISO 228-1 (B.S.P)
	115	Fitting w/inside screw thread
	114	Quick coupling

Krøger A/S - Geminivej 4-6 - DK-2670 Greve - Denmark - Phone: +45 43600111 - Fax: +45 43690137  
www.mk-guns.dk - mail@mk-guns.dk







- the original since 1922 -

# Quick Coupling Set no. 1

The World's Strongest Caulking Gun

	Article no.	Description
	118	Hose union w/outside screw thread
	121a (1/4")	Hose clamp
	110 (1/4")	Reinforced Pneumatic hose

Krøger A/S - Geminivej 4-6 - DK-2670 Greve - Denmark - Phone: +45 43600111 - Fax: +45 43690137  
[www.mk-guns.dk](http://www.mk-guns.dk) - [mail@mk-guns.dk](mailto:mail@mk-guns.dk)





- the original since 1922 -

## Quick Coupling Set no. 2

### Quick Coupling Set no. 2

All of the MK-pneumatic Caulking Guns are supplied with a 1/4" European thread fitting, but upon request we supply also with 1/4" US thread. Please contact us if you have any additional requests.

	Article no.	Description
	1617 48917	1/4" ISO 228-1 (B.S.P)
	119	Hose union
	121a (1/4")	Hose clamp

Krøger A/S - Geminivej 4-6 - DK-2670 Greve - Denmark - Phone: +45 43600111 - Fax: +45 43690137  
www.mk-guns.dk - mail@mk-guns.dk





- the original since 1922 -

## Quick Coupling Set no. 2

The World's Strongest Caulking Gun

	110 (1/4")	Reinforced Pneumatic hose
---	------------	---------------------------

Krøger A/S - Geminivej 4-6 - DK-2670 Greve - Denmark - Phone: +45 43600111 - Fax: +45 43690137  
www.mk-guns.dk - mail@mk-guns.dk





- the original since 1922 -

## Quick Coupling Set

### Fittings

All of the MK-pneumatic Caulking Guns are supplied with an 1/4" European thread fitting, but upon request we supply also with 1/4" US thread. Please contact us if you have any additional requests.

	Article no.	Description
	116	Fitting w/outside screw thread
	117	Fitting w/Hose union

Krøger A/S - Geminivej 4-6 - DK-2670 Greve - Denmark - Phone: +45 43600111 - Fax: +45 43690137  
[www.mk-guns.dk](http://www.mk-guns.dk) - [mail@mk-guns.dk](mailto:mail@mk-guns.dk)



# THE WORLD'S STRONGEST CAULKING GUNS

Since 1922 Quality-conscious customers worldwide have used caulking guns from Krøger A/S. Over the years we have set new industry standards and it is our ambition constantly to stay abreast of developments and provide modern products through a consistent focus on the development of high quality products and reliable delivery.

## **Quality and competence in every detail**

At Krøger A / S, we continuously invest in new technology, in a good and safe working environment, in ensuring the quality of our products and in the training of our employees. We do this because we believe that a successful and innovative organization ensures superior products of a high and uniform quality.

Today we work close together with some of the world's leading tool and sealants manufacturers, and we collaborate with a wide range of businesses and customers. We supply both standard products and customized solutions - and one of our main objectives is, always to deliver on time, because we know how important it can be to your business.

You can read more about Krøger A / S, cases, news and technical information on **[www.mk-guns.dk](http://www.mk-guns.dk)**.